



Single impeller centrifugal pump, extremely silent suitable for household, civil and industrial applications, with a very flat curve to guarantee constant pressure at the variation of the flow.

Construction features

Pump body	cast iron
Motor bracket	cast iron (45, 50, 164-550); aluminum (KM 86-106)
Impeller	Noryl® (45) Noryl® or brass (50-314) brass (400-550)
Mechanical seal	ceramic-graphite-NBR
Motor shaft	steel AISI 416 (45÷106) steel AISI 303 (164÷550)
Liquid temperature	Noryl® impeller: 0 - 50 °C brass impeller: 0 - 90 °C
Operating pressure	max 6 bar (45-106) max 8 bar (164-550)

Motor

	3~ 230/400V-50Hz
2 Poles induction motor	1~ 230V-50Hz (with thermal protection up to MEC 80)
Insulation class	F
Protection degree	IPX4

TYPE	LOTS			
	TRUCK		CONTAINER	
	PALLET (cm)	N° pumps	PALLET (cm)	N° pumps
KM 45-50	80×120×145	102	80×120×190	136
KM 86-106	85×110×145	65	85×110×195	91
KM 164-314	85×110×140	40	85×110×170	60
KM 314	85×110×150	24	85×110×180	30
KM 400-550	85×110×150	24	85×110×180	30

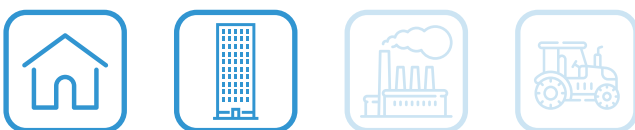
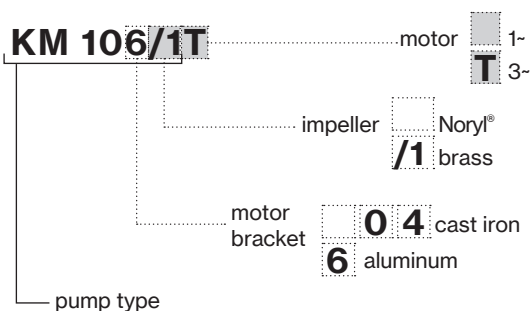

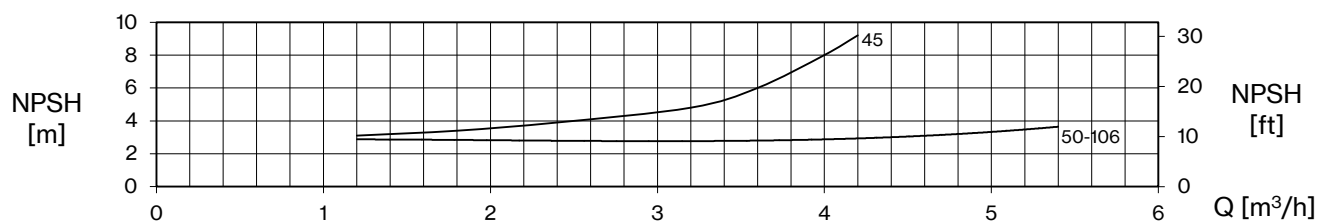
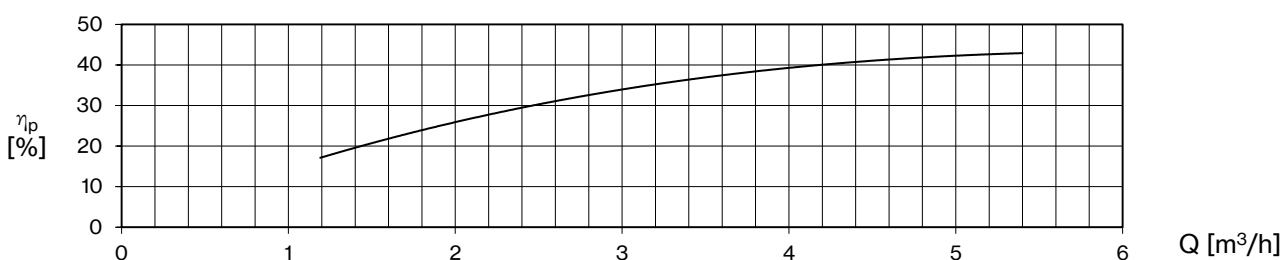
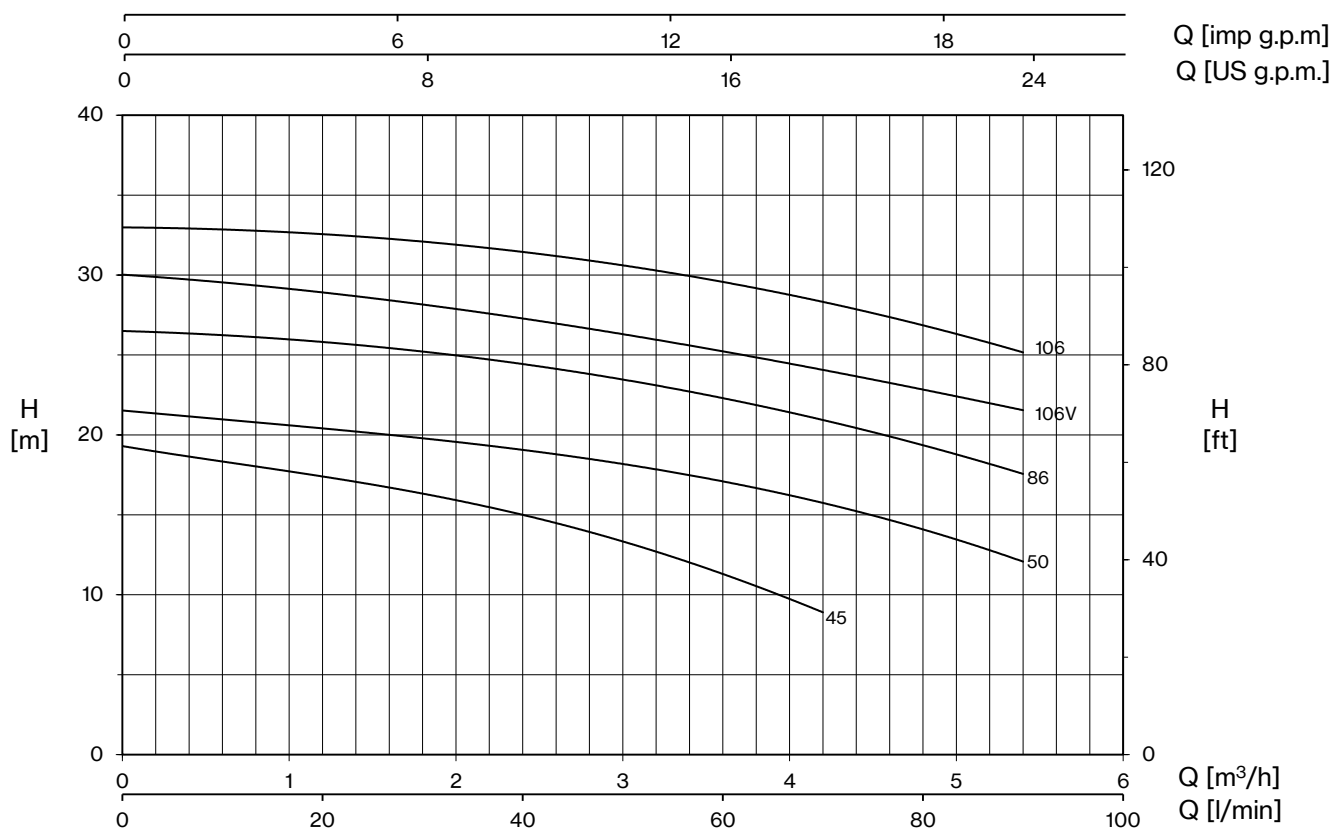

TYPE		P2		P1 (kW)		AMPERE		Q (m³/h - l/min)						
1-	3-	HP	kW	1-	3-	1x230 V 50 Hz	3x400 V 50 Hz	0	1,2	2,4	3,6	4,2	4,8	5,4
								0	20	40	60	70	80	90
								H (m)						
KM 45	KM 45 T	0,4	0,3	0,51	0,56	2,3	1	19,3	17,4	15,0	11,3	8,9		
KM 50	KM 50 T	0,5	0,37	0,59	0,65	2,8	1,1	21,5	20,5	19,0	17,0	15,8	14,2	12,0
KM 86	KM 86 T	0,8	0,59	0,9	0,94	4,5	1,7	26,5	25,8	24,5	22,2	20,9	19,5	17,5
KM 106 V	-	1	0,74	1,05	-	4,6	-	30,0	29,0	27,2	25,2	24,1	22,9	21,5
KM 106	KM 106 T	1	0,74	1,16	1,17	5,7	2	33,0	32,5	31,5	29,6	28,3	26,8	25,2

KM

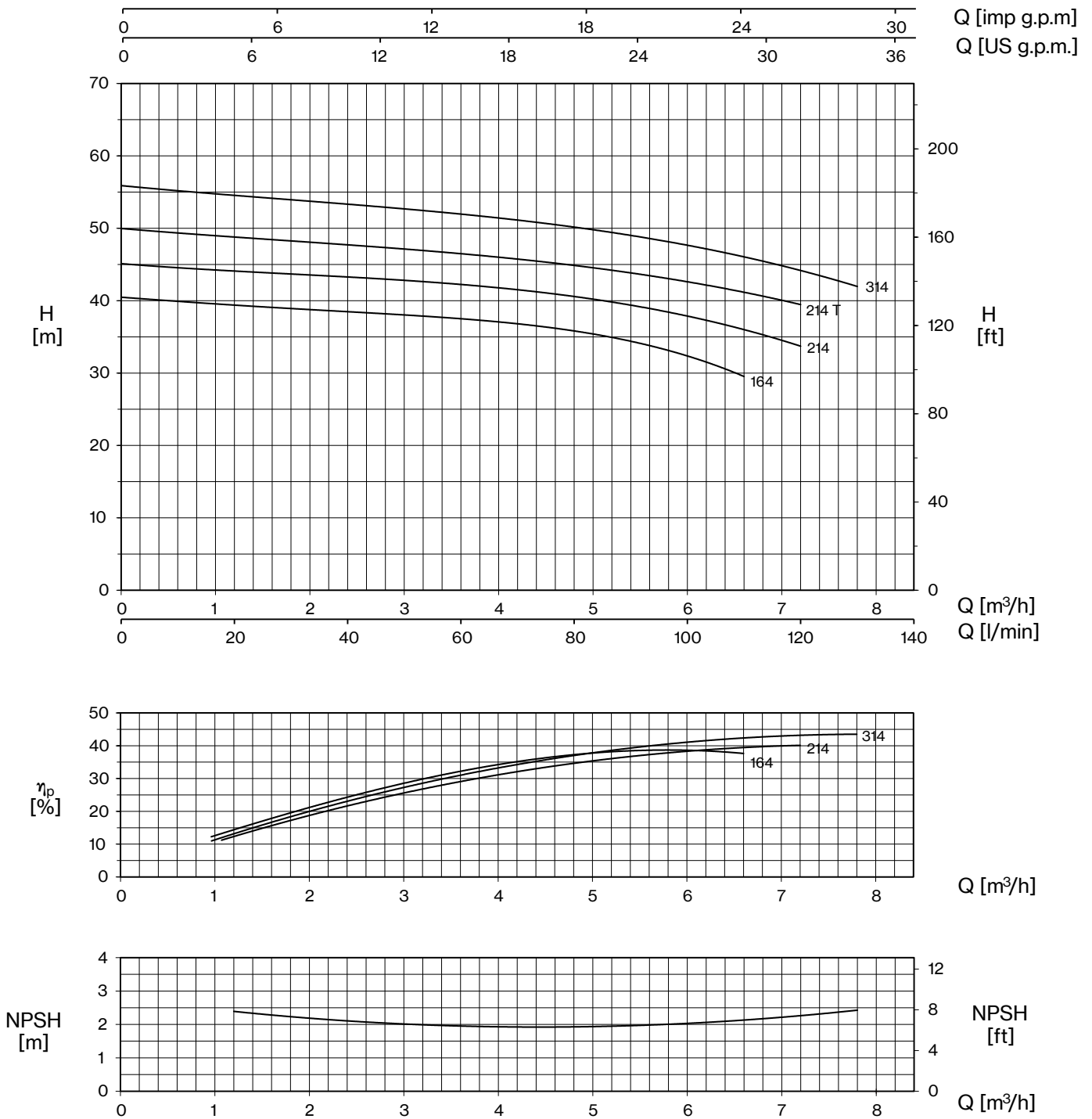

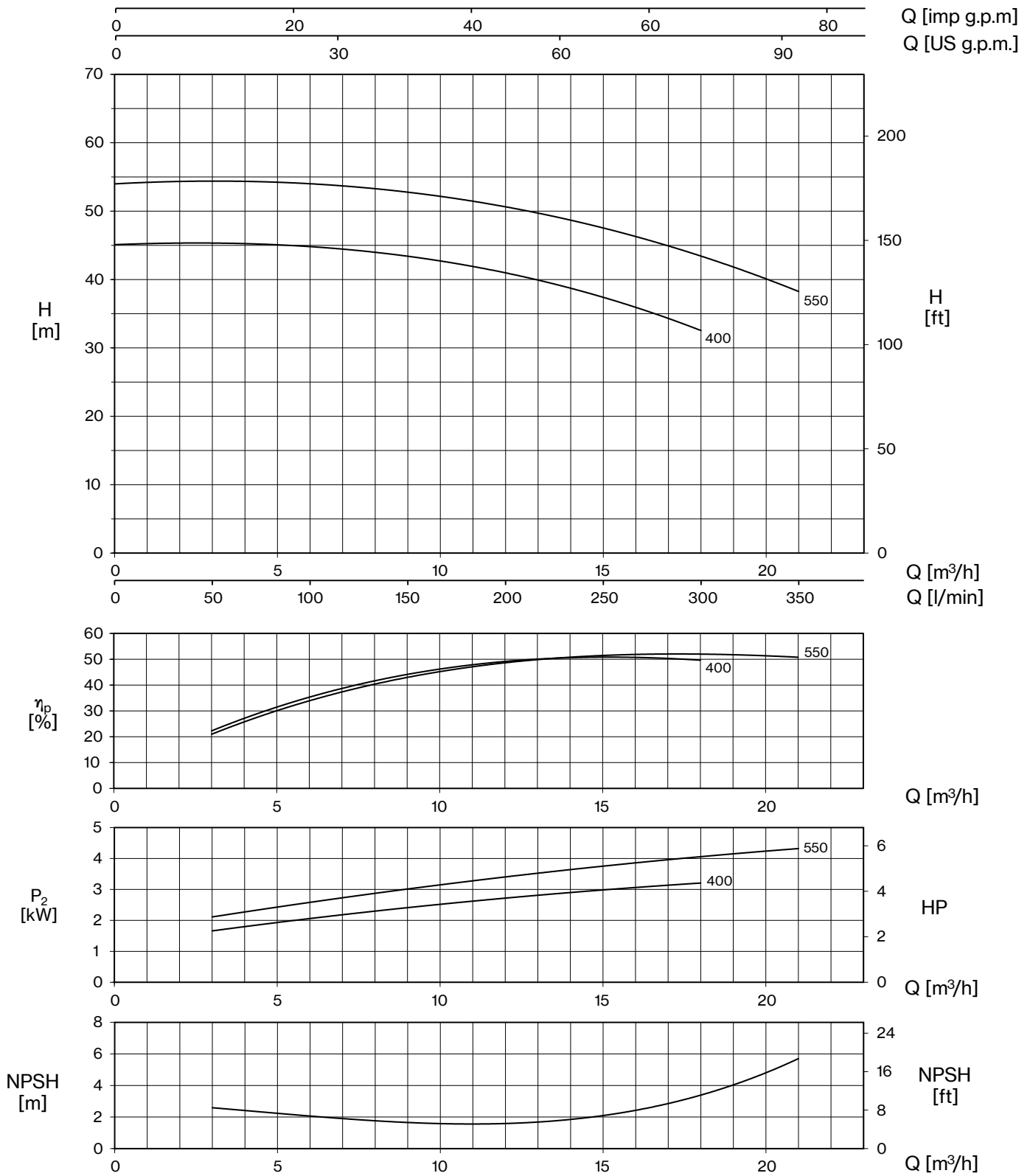

TYPE		P2		P1 (kW)		AMPERE		Q (m³/h - l/min)								
1~	3~	HP	kW	1~	3~	1~	3~	0	1,2	2,4	3,6	4,8	5,4	6,6	7,2	7,8
								0	20	40	60	80	90	110	120	130
						1x230 V 50 Hz	3x400 V 50 Hz	H (m)								
KM 164	KM 164 T	1,5	1,1	1,9	1,8	8,5	3,4	40,5	39,3	38,6	37,5	35,6	34,6	29,5		
KM 214	-	2	1,5	2,2	-	10,3	-	45,1	44,1	43,3	42,3	40,5	39,2	36,4	33,5	
-	KM 214 T	2	1,5	-	2,43	-	4,9	50,0	48,7	47,8	46,5	44,9	43,7	41,3	39,4	
KM 314	KM 314 T	3	2,2	2,85	2,67	13,5	5,1	55,9	54,5	53,4	52,0	50,1	48,9	46,2	44,2	41,9

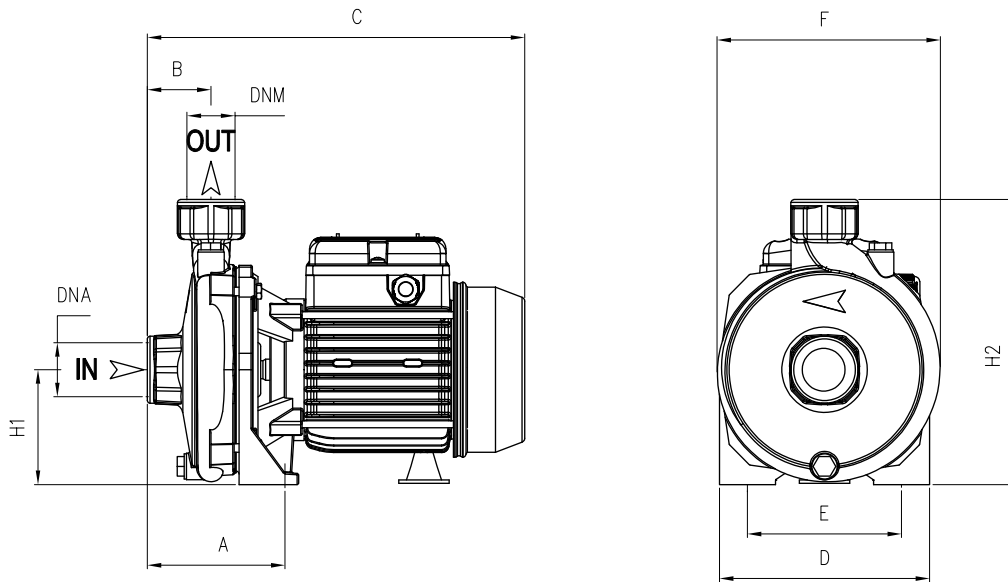

TYPE		P2		P1 (kW)		AMPERE		Q (m³/h - l/min)							
1~	3~	HP	kW	1~	3~	1~	3~	0	3	6	9	12	15	18	21
								0	50	100	150	200	250	300	350
						1x230 V 50 Hz	3x400 V 50 Hz	H (m)							
KM 400	KM 400 T	4	3	3,6	3,7	16,0	6,7	45,1	45,2	44,9	43,4	40,9	37,4	32,5	
-	KM 550 T	5,5	4	-	4,9	-	9,0	54,1	54,1	54,0	52,9	50,7	47,5	43,2	38,4

KM



TYPE	DIMENSIONS (mm)														
	A	B	C	D	E	F	H1	H2	DNA	DNM	I	L	M	kg	T
KM 45	95	45,5	265	150	110	160	82	202			290	175	225	8,5	
KM 50	95	45,5	265	150	110	160	82	202			290	170	230	9,5	
KM 86	110	46,5	300	180	140	185	97	234	1" G	1" G	325	200	265	13,5	T 13
KM 106 V	110	46,5	300	180	140	185	97	234			325	200	265	14	T 13,5
KM 106	110	46,5	300	180	140	185	97	234			325	200	265	15	T 14,5
KM 164	117	46,5	348	220	180	225	115	285			370	240	315	23	T 22
KM 214	117	46,5	348	220	180	225	115	285	1" ¼ G	1" G	370	240	315	24	T 23
KM 314	117	46,5	M 410	220	180	225	115	285			370	240	315	29	T 23,5
KM 400	108	54	460	240	190	250	133	323	2" G	1" ¼ G	480	255	342	46	T 41,5
KM 550 T	108	54	460	240	190	250	133	323			480	255	342	46	T 45,5